

# Fiche de réception retour chantier – MADP P





|                |  |
|----------------|--|
| Entreprise:    |  |
| Vérificateur : |  |
| Date :         |  |
| Signature :    |  |

## Fiche de réception retour chantier – MADP P

| Référence   | Désignation                       | Visuel   | Etat | Nombre de pièces à commander |
|-------------|-----------------------------------|--|------|------------------------------|
| 12129065PR  | Equerre face bas R                |     |      |                              |
| 005700065PR | Ensemble platine + centreur MAD P |     |      |                              |
| 005700060PR | Plateau                           |     |      |                              |
| 005700054PR | Plateau complet                   |     |      |                              |
| 005700030   | Verrou portillon MAD              |     |      |                              |
| 005300010   | Portillon                         |     |      |                              |
| 12104534    | Montant arrière gauche portillon  |    |      |                              |
| 12104535    | Montant arrière droit portillon   |   |      |                              |
| 005700025PR | Verrou glissière                  |   |      |                              |
| 005700021   | Glissière renforcée               |   |      |                              |
| 1233201PR   | Marche Accès Dalle                |  |      |                              |
| 005400020PR | Roue Déportée PDA                 |   |      |                              |
| 14013PR     | Roue diamètre 200                 |   |      |                              |
| 16329       | Anneau de levage                  |   |      |                              |

## Fiche de réception retour chantier – MADP P

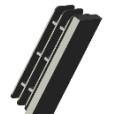
| Référence | Désignation               | Visuel   | Etat | Nombre de pièces à commander |
|-----------|---------------------------|--|------|------------------------------|
| 17101     | RENRANT 30 X 30           |   |      |                              |
| 17102     | RENRANT 30 x 40           |   |      |                              |
| 17105     | Renrant 30 x 60           |   |      |                              |
| 17108     | RENRANT 30 X 80           |   |      |                              |
| 17903PR   | Patin enveloppant 60 Bleu |  |      |                              |

# Fiche de réception retour chantier – MADP 2 P

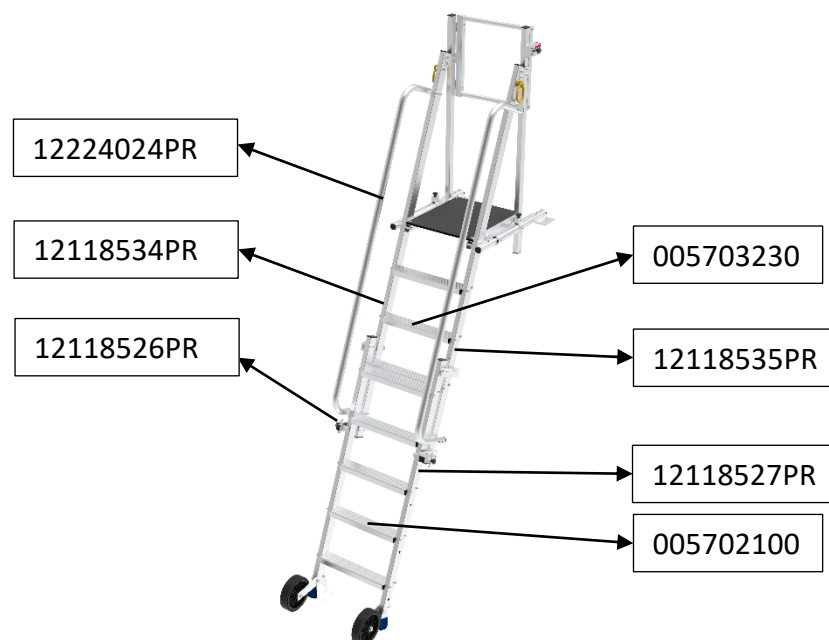

| Référence  | Désignation                      | Visuel | Etat | Nombre à remplacer |
|------------|----------------------------------|--------|------|--------------------|
| 005702100  | Echelle Inf MAD 2                |        |      |                    |
| 005703230  | Echelle Sup MAD3 prémonté        |        |      |                    |
| 12118526PR | Montant Gauche Echelle Inf MAD 2 |        |      |                    |
| 12118527PR | Montant Droit Echelle Inf MAD 2  |        |      |                    |
| 12118534PR | Montant Gauche Echelle Sup       |        |      |                    |
| 12118535PR | Montant Droit Echelle Sup        |        |      |                    |
| 12224024PR | Rampe MAD 3                      |        |      |                    |



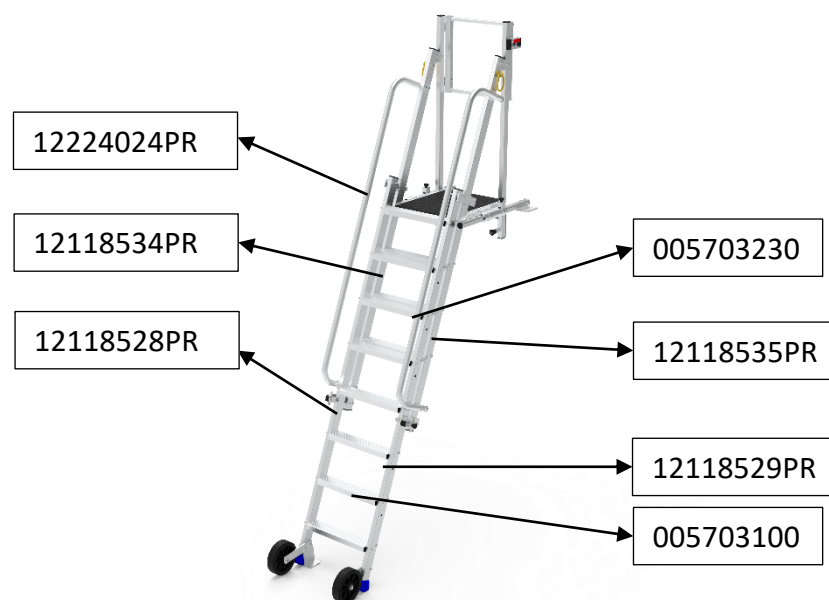



# Fiche de réception retour chantier – MADP 3 P

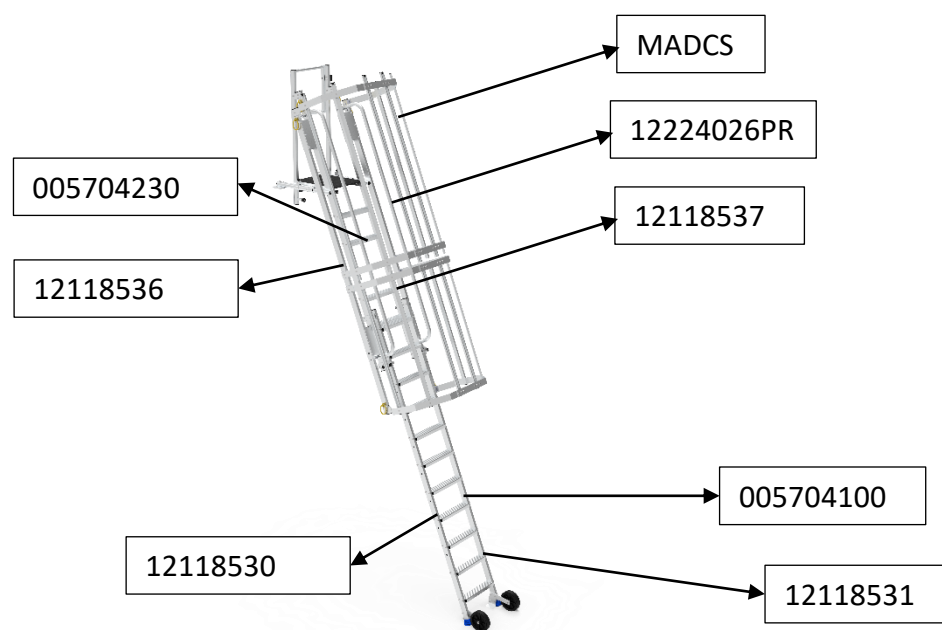

| Référence  | Désignation                      | Visuel | Etat | Nombre à remplacer |
|------------|----------------------------------|--------|------|--------------------|
| 005703100  | Echelle Inf MAD 3                |        |      |                    |
| 005703230  | Echelle Sup MAD3 prémonté        |        |      |                    |
| 12118528PR | Montant Gauche Echelle Inf MAD 3 |        |      |                    |
| 12118529PR | Montant Droit Echelle Inf MAD 3  |        |      |                    |
| 12118534PR | Montant Gauche Echelle Sup       |        |      |                    |
| 12118535PR | Montant Droit Echelle Sup        |        |      |                    |
| 12224024PR | Rampe MAD 3                      |        |      |                    |





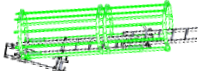

# Fiche de réception retour chantier – MADP 4 P

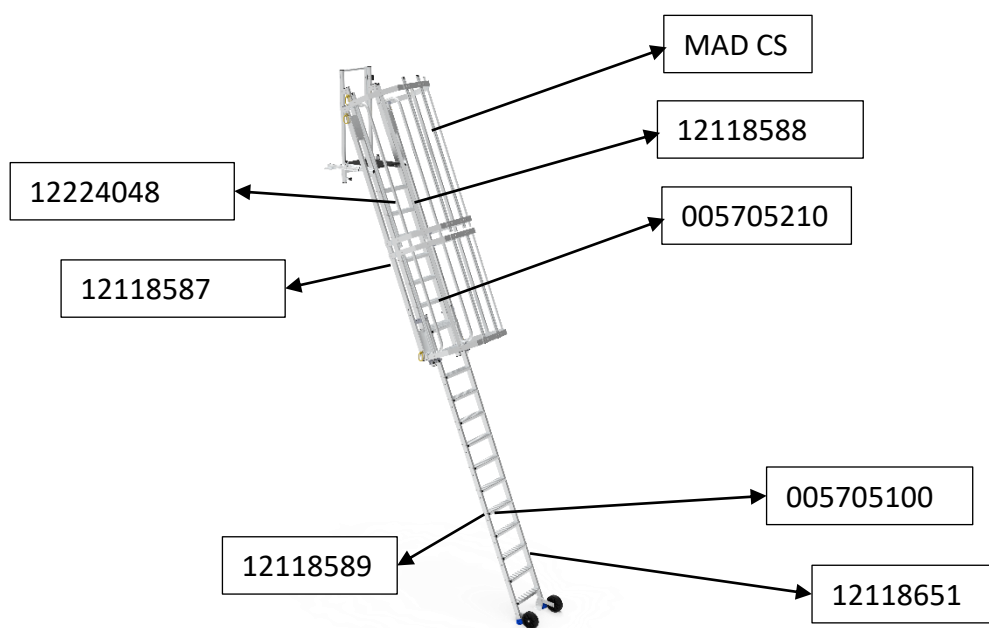

| Référence  | Désignation                      | Visuel  | Etat | Nombre à remplacer |
|------------|----------------------------------|---|------|--------------------|
| 005704100  | Echelle Inf MAD 4                |  |      |                    |
| 005704230  | Echelle Sup MAD4 Prémonté        |  |      |                    |
| 12118536   | Montant Escalier Sup Gauche MAD4 |  |      |                    |
| 12118537   | Montant Escalier Sup Droit MAD4  |  |      |                    |
| 12118530   | Montant Escalier Inf Gauche MAD4 |  |      |                    |
| 12118531   | Montant Escalier Inf Droit MAD4  |  |      |                    |
| 12224026PR | Rampe MAD 4                      |  |      |                    |
| MADCS      | Crinoline MAD 4 P                |  |      |                    |

# Fiche de réception retour chantier – MADP 5 P

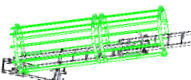

| Référence | Désignation                      | Visuel  | Etat | Nombre à remplacer |
|-----------|----------------------------------|---|------|--------------------|
| 005705100 | Echelle Inf MAD 5                |  |      |                    |
| 005705210 | Echelle Sup MAD5 Prémonté        |  |      |                    |
| 12118589  | Montant Gauche Echelle Inf MAD 5 |  |      |                    |
| 12118651  | Montant Droit Echelle Inf MAD 5  |  |      |                    |
| 12118587  | Montant Gauche Echelle Sup MAD 5 |  |      |                    |
| 12118588  | Montant Droit Echelle Sup MAD 5  |  |      |                    |
| 12224048  | Rampe MAD 5                      |  |      |                    |
| MADCS     | Crinoline MAD 5                  |  |      |                    |



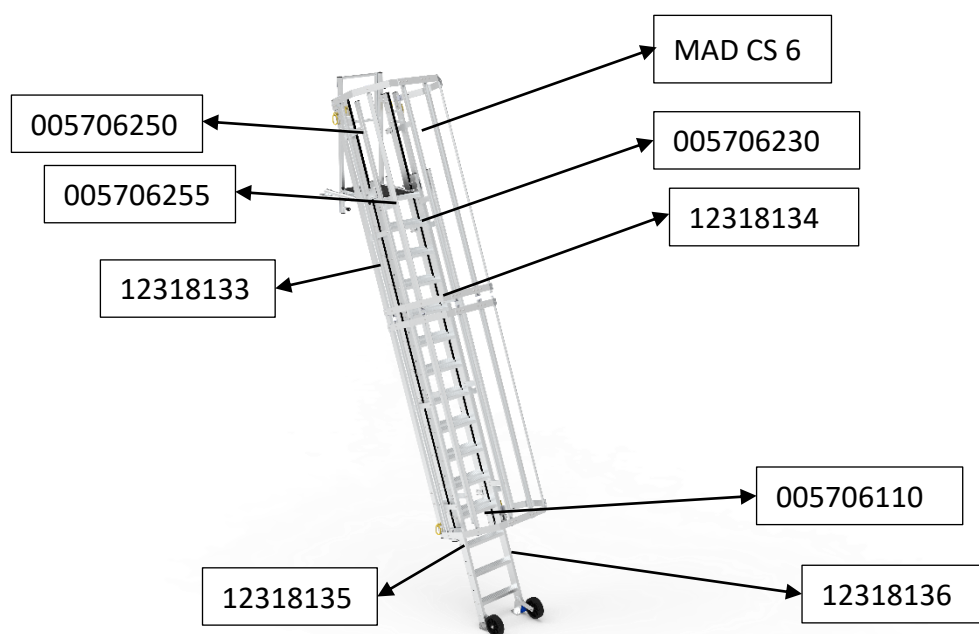



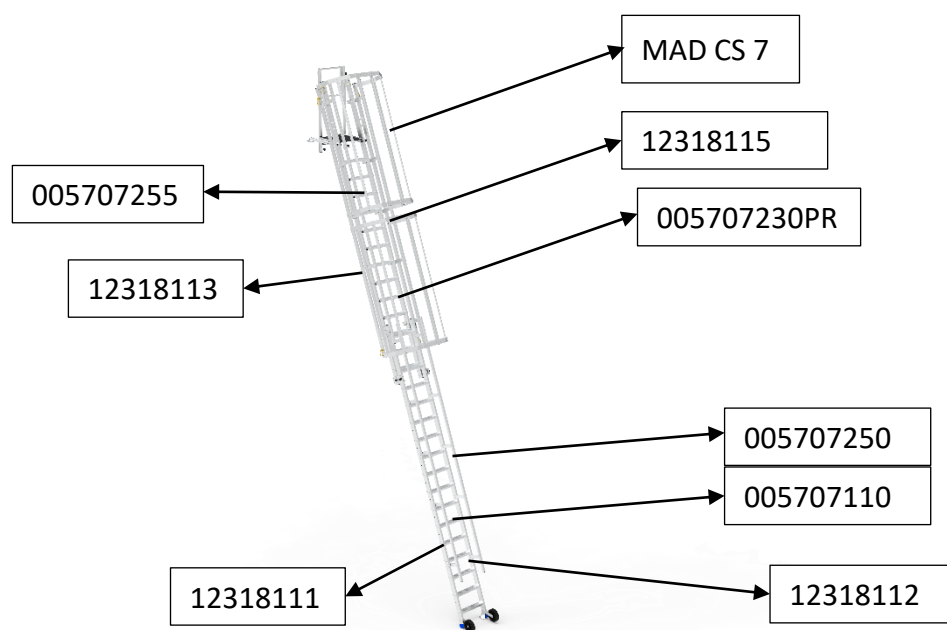

# Fiche de réception retour chantier – MADP 6 P



| Référence | Désignation                      | Visuel | Etat | Nombre à remplacer |
|-----------|----------------------------------|--------|------|--------------------|
| 005706110 | Echelle Inf MAD 6                |        |      |                    |
| 005706230 | Echelle Sup MAD 6 Prémonté       |        |      |                    |
| 12318135  | Montant Gauche Echelle Inf MAD 6 |        |      |                    |
| 12318136  | Montant Droit Echelle Inf MAD 6  |        |      |                    |
| 12318133  | Montant Gauche Echelle Sup MAD 6 |        |      |                    |
| 12318134  | Montant Droit Echelle Sup MAD 6  |        |      |                    |
| 005706255 | Rampe SUP MAD 6                  |        |      |                    |
| 005706250 | Rampe INF MAD 6                  |        |      |                    |
| MADCS 6   | PROTECTION CRINO MAD 6           |        |      |                    |







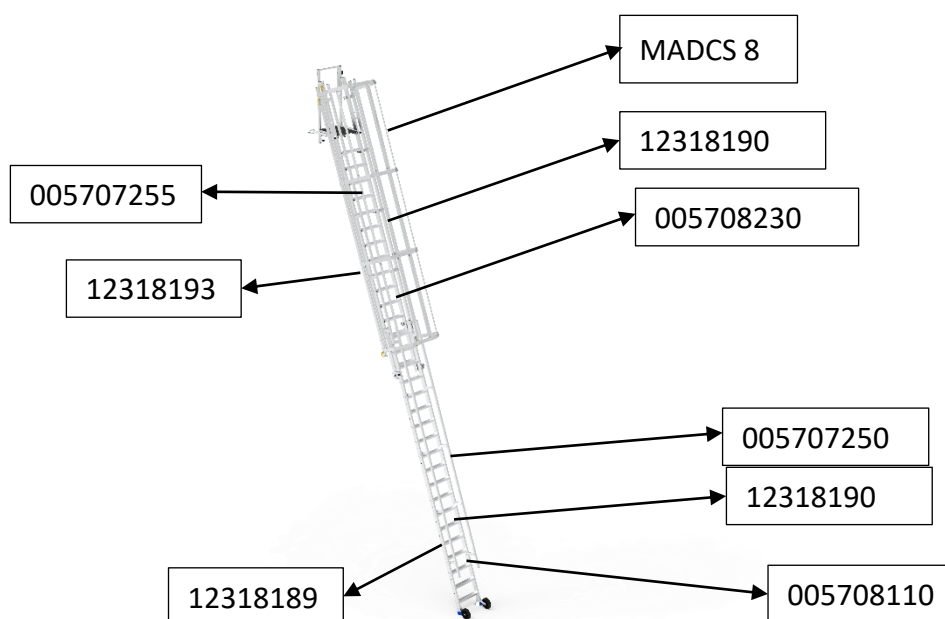

# Fiche de réception retour chantier – MADP 7 P



| Référence   | Désignation                      | Visuel  | Etat | Nombre à remplacer |
|-------------|----------------------------------|---|------|--------------------|
| 005707110   | Echelle Inf MAD 7                |  |      |                    |
| 005707230PR | Echelle Sup MAD7 Prémonté        |  |      |                    |
| 12318111    | Montant Gauche Echelle Inf MAD 7 |  |      |                    |
| 12318112    | Montant Droit Echelle Inf MAD 7  |  |      |                    |
| 12318113    | Montant Gauche Echelle Sup MAD 7 |  |      |                    |
| 12318115    | Montant Droit Echelle Sup MAD 7  |  |      |                    |
| 005707250   | Rampe INF MAD 7                  |  |      |                    |
| 005707255   | Rampe SUP MAD 7                  |  |      |                    |
| MADCS 7     | PROTECTION CRINO MAD 7           |  |      |                    |

# Fiche de réception retour chantier – MADP 8 P



| Référence | Désignation                      | Visuel  | Etat | Nombre à remplacer |
|-----------|----------------------------------|---|------|--------------------|
| 005708110 | Echelle Inf MAD 8                |  |      |                    |
| 005708230 | Echelle Sup MAD8 Prémonté        |  |      |                    |
| 12318189  | Montant Gauche Echelle Inf MAD 8 |  |      |                    |
| 12318190  | Montant Droit Echelle Inf MAD 8  |  |      |                    |
| 12318193  | Montant Gauche Echelle Sup MAD 8 |  |      |                    |
| 12318194  | Montant Droit Echelle Sup MAD 8  |  |      |                    |
| 005707250 | Rampe INF MAD 8                  |  |      |                    |
| 005707255 | Rampe SUP MAD 8                  |  |      |                    |
| MADCS 8   | PROTECTION CRINO MAD 8           |  |      |                    |