

# Fiche de réception retour chantier – MADP P



Entreprise:	
Vérificateur :	
Date :	
Signature :	

## Fiche de réception retour chantier – MADP P

Référence	Désignation	Visuel	Etat	Nombre de pièces à commander
12129065PR	Equerre face bas R			
005700065PR	Ensemble platine + centreur MAD P			
005700060PR	Plateau			
005700054PR	Plateau complet			
005700030	Verrou portillon MAD			
005300010	Portillon			
12104534	Montant arrière gauche portillon			
12104535	Montant arrière droit portillon			
005700025PR	Verrou glissière			
005700021	Glissière renforcée			
1233201PR	Marche Accès Dalle			
005400020PR	Roue Déportée PDA			
14013PR	Roue diamètre 200			
16329	Anneau de levage			

## Fiche de réception retour chantier – MADP P

Référence	Désignation	Visuel	Etat	Nombre de pièces à commander
17101	RENRANT 30 X 30			
17102	RENRANT 30 x 40			
17105	Renrant 30 x 60			
17108	RENRANT 30 X 80			
17903PR	Patin enveloppant 60 Bleu			

# Fiche de réception retour chantier – MADP 2 P

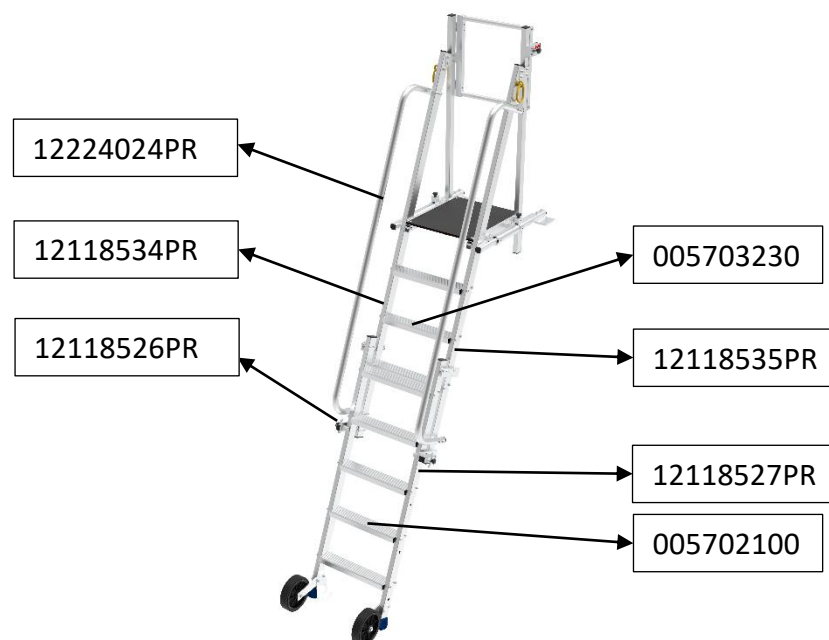

Référence	Désignation	Visuel	Etat	Nombre à remplacer
005702100	Echelle Inf MAD 2			
005703230	Echelle Sup MAD3 prémonté			
12118526PR	Montant Gauche Echelle Inf MAD 2			
12118527PR	Montant Droit Echelle Inf MAD 2			
12118534PR	Montant Gauche Echelle Sup			
12118535PR	Montant Droit Echelle Sup			
12224024PR	Rampe MAD 3			



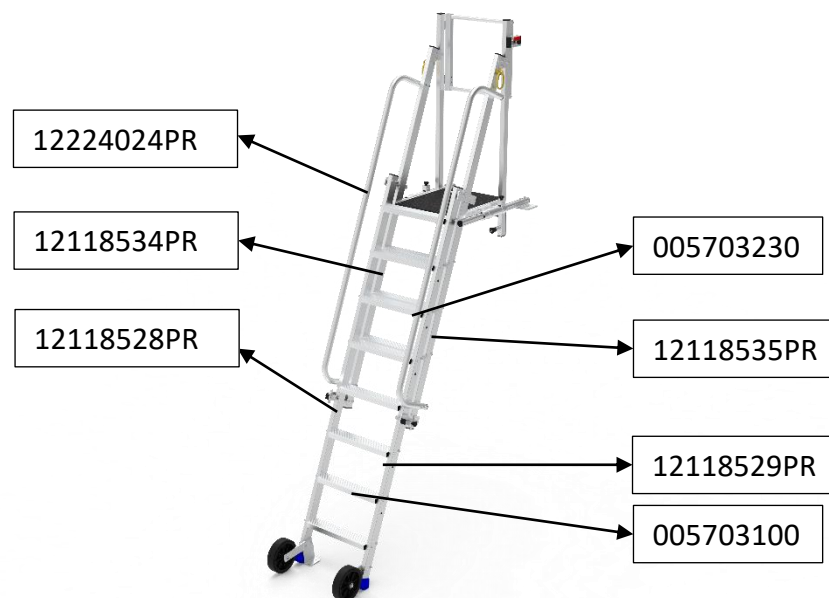



# Fiche de réception retour chantier – MADP 3 P

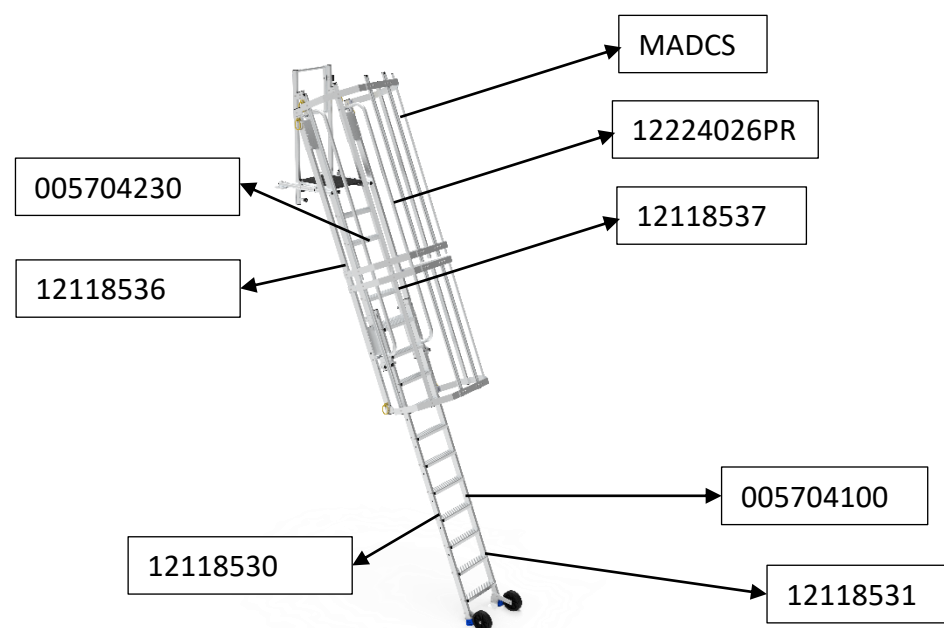

Référence	Désignation	Visuel	Etat	Nombre à remplacer
005703100	Echelle Inf MAD 3			
005703230	Echelle Sup MAD3 prémonté			
12118528PR	Montant Gauche Echelle Inf MAD 3			
12118529PR	Montant Droit Echelle Inf MAD 3			
12118534PR	Montant Gauche Echelle Sup			
12118535PR	Montant Droit Echelle Sup			
12224024PR	Rampe MAD 3			





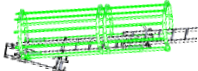

# Fiche de réception retour chantier – MADP 4 P

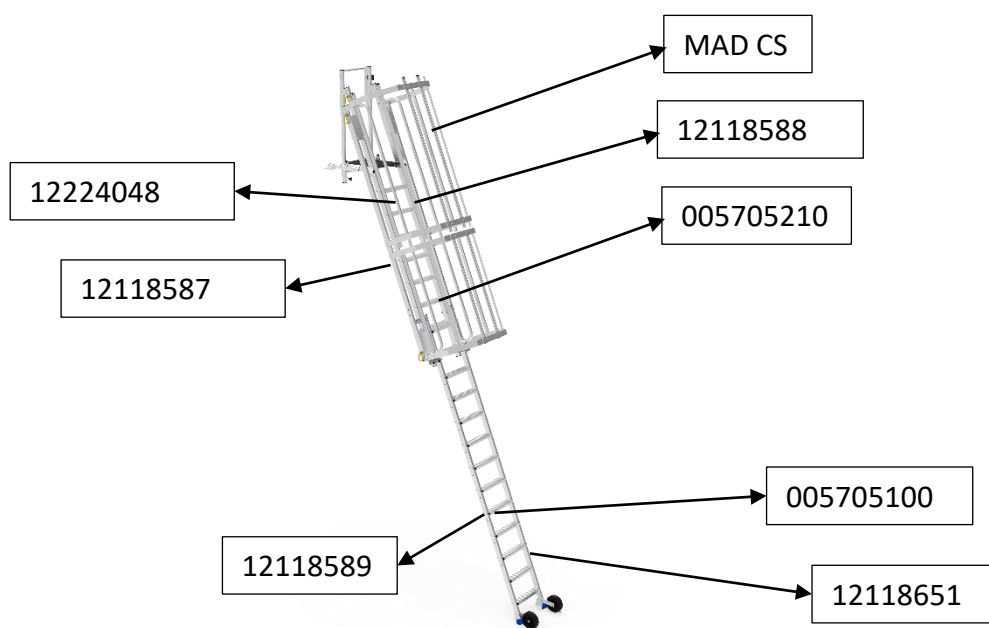

Référence	Désignation	Visuel	Etat	Nombre à remplacer
005704100	Echelle Inf MAD 4			
005704230	Echelle Sup MAD4 Prémonté			
12118536	Montant Escalier Sup Gauche MAD4			
12118537	Montant Escalier Sup Droit MAD4			
12118530	Montant Escalier Inf Gauche MAD4			
12118531	Montant Escalier Inf Droit MAD4			
12224026PR	Rampe MAD 4			
MADCS	Crinoline MAD 4 P			

# Fiche de réception retour chantier – MADP 5 P

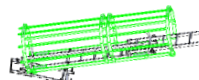

Référence	Désignation	Visuel	Etat	Nombre à remplacer
005705100	Echelle Inf MAD 5			
005705210	Echelle Sup MAD5 Prémonté			
12118589	Montant Gauche Echelle Inf MAD 5			
12118651	Montant Droit Echelle Inf MAD 5			
12118587	Montant Gauche Echelle Sup MAD 5			
12118588	Montant Droit Echelle Sup MAD 5			
12224048	Rampe MAD 5			
MADCS	Crinoline MAD 5			

# Fiche de réception retour chantier – MADP 6 P

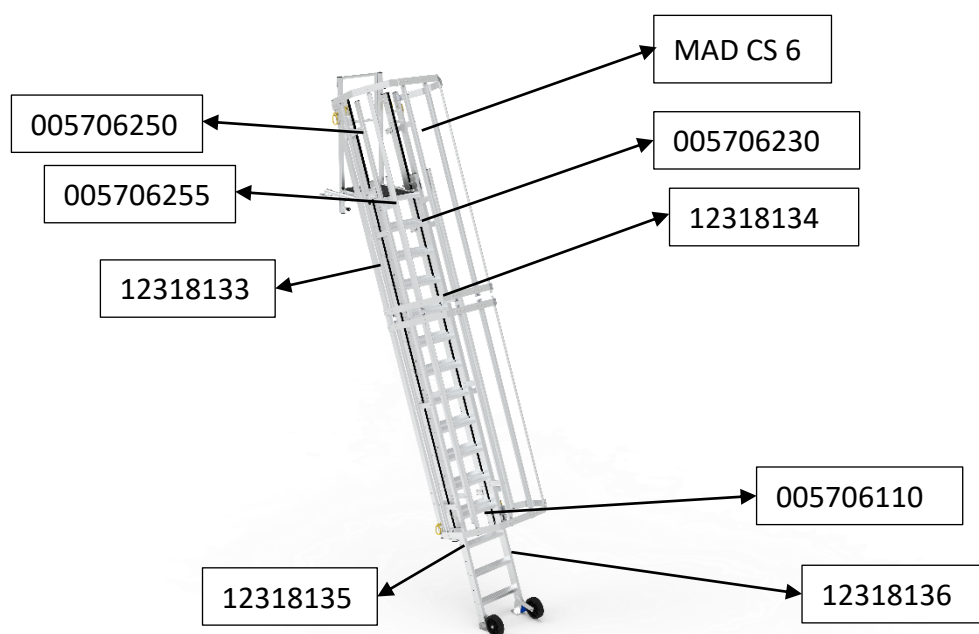







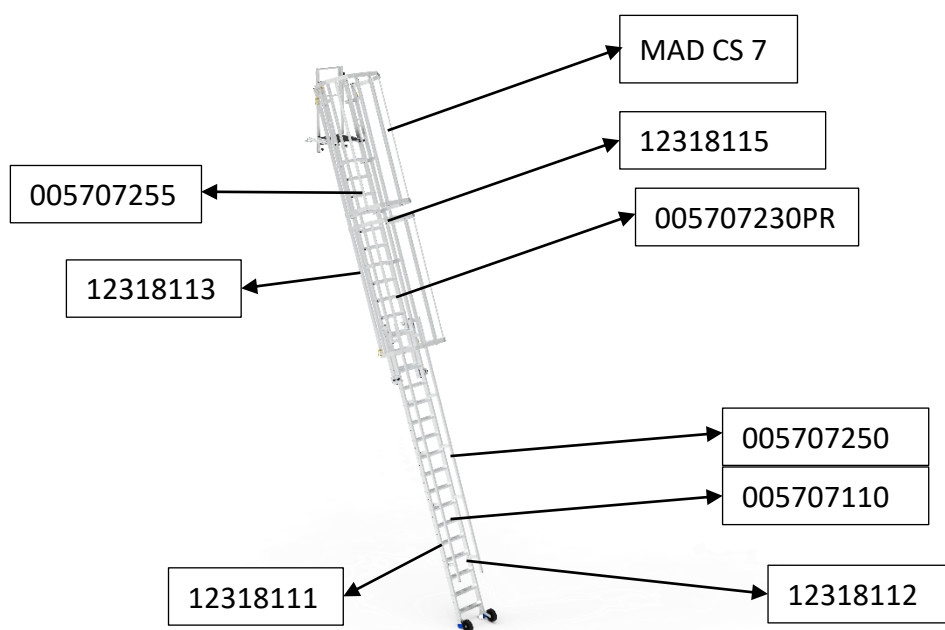

Référence	Désignation	Visuel	Etat	Nombre à remplacer
005706110	Echelle Inf MAD 6			
005706230	Echelle Sup MAD 6 Prémonté			
12318135	Montant Gauche Echelle Inf MAD 6			
12318136	Montant Droit Echelle Inf MAD 6			
12318133	Montant Gauche Echelle Sup MAD 6			
12318134	Montant Droit Echelle Sup MAD 6			
005706255	Rampe SUP MAD 6			
005706250	Rampe INF MAD 6			
MADCS 6	PROTECTION CRINO MAD 6			



# Fiche de réception retour chantier – MADP 7 P



Référence	Désignation	Visuel	Etat	Nombre à remplacer
005707110	Echelle Inf MAD 7			
005707230PR	Echelle Sup MAD7 Prémonté			
12318111	Montant Gauche Echelle Inf MAD 7			
12318112	Montant Droit Echelle Inf MAD 7			
12318113	Montant Gauche Echelle Sup MAD 7			
12318115	Montant Droit Echelle Sup MAD 7			
005707250	Rampe INF MAD 7			
005707255	Rampe SUP MAD 7			
MADCS 7	PROTECTION CRINO MAD 7			

# Fiche de réception retour chantier – MADP 8 P

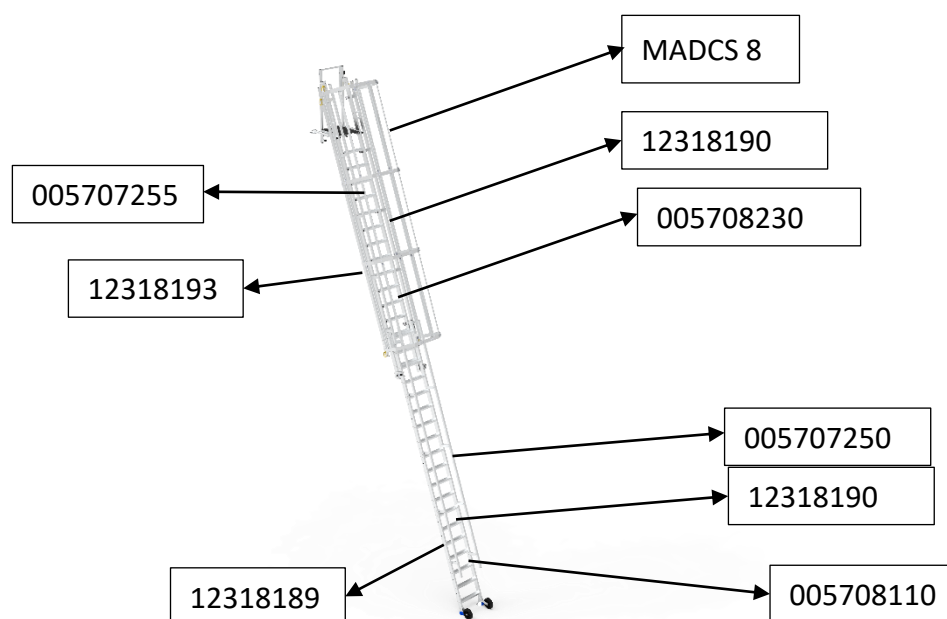

Référence	Désignation	Visuel	Etat	Nombre à remplacer
005708110	Echelle Inf MAD 8			
005708230	Echelle Sup MAD8 Prémonté			
12318189	Montant Gauche Echelle Inf MAD 8			
12318190	Montant Droit Echelle Inf MAD 8			
12318193	Montant Gauche Echelle Sup MAD 8			
12318194	Montant Droit Echelle Sup MAD 8			
005707250	Rampe INF MAD 8			
005707255	Rampe SUP MAD 8			
MADCS 8	PROTECTION CRINO MAD 8			